

DR-1/DR-2/DR-3

Owner's Manual

WARNING

TO PREVENT FIRE OR SHOCK HAZARD, DO NOT EXPOSE THIS APPLIANCE TO RAIN OR MOISTURE.



CAUTION

**TO REDUCE THE RISK OF ELECTRIC SHOCK, DO NOT REMOVE COVER (OR BACK).
NO USER-SERVICEABLE PARTS INSIDE.
REFER SERVICING TO QUALIFIED SERVICE PERSONNEL.**



The lightning flash with arrowhead symbol, within an equilateral triangle, is intended to alert the user of the presence of uninsulated "dangerous voltage" within the product's enclosure; that may be of sufficient magnitude to constitute a risk of electric shock to persons.



The exclamation point within an equilateral triangle is intended to alert the user of the presence of important operating and maintenance (servicing) instructions in the literature accompanying the appliance.

This equipment generates and uses radio frequency energy and if not installed and used properly, that is, in strict accordance with the manufacturer's instructions, may cause interference to radio and television reception. It has been type tested and found to comply with the limits for a Class B computing device in accordance with the specifications in Subpart J of Part 15 of FCC Rules, which are designed to provide reasonable protection against such interference in a residential installation. However, there is no guarantee that interference will not occur in a particular installation. If this equipment does cause interference to radio or television reception, which can be determined by turning the equipment off and on, the user is encouraged to try to correct the interference by one or more of the following measures:

- reorient the receiving antenna
- relocate this equipment with respect to the receiver
- move this equipment away from the receiver
- plug this equipment into a different outlet so that equipment and receiver are on different branch circuits.

If necessary, the user should consult the dealer or an experienced radio/television technician for additional suggestions. The user may find the following booklet prepared by the Federal Communications Commission helpful:

"How to identify and Resolve Radio-TV interference Problems".

This booklet is available from the U.S. Government Printing Office, Washington, DC 20402, Stock No.004-000-00345-4.

This digital apparatus does not exceed the CLASS B Limits for radio noise emissions from digital apparatus set out in the Radio Interference Regulations of the Canadian Department of Communications.

Please record the Serial Number in the space provided below and retain these numbers. The Serial Number is located on the rear panel of the unit.

Model Number: DR-1/DR-2/DR-3

Serial Number: _____

Precautions

1. Caring for the exterior panels of the unit should be limited to wiping with a soft, dry cloth. Avoid using solvents or alcohol-based cleaners.
2. Voltage Selector (Special Equipment)
A special version of this unit with a voltage selector on the rear panel is sold in areas other than North America, Australia, and Europe.
If the model you have purchased is a version with voltage selector, be sure to confirm that the voltage selector selector is set to the correct AC voltage used in your area. Make this check before plugging the power cord into the AC outlet. If the selector is not set correctly, change the setting so that it matches your local AC voltage rating.

Controls

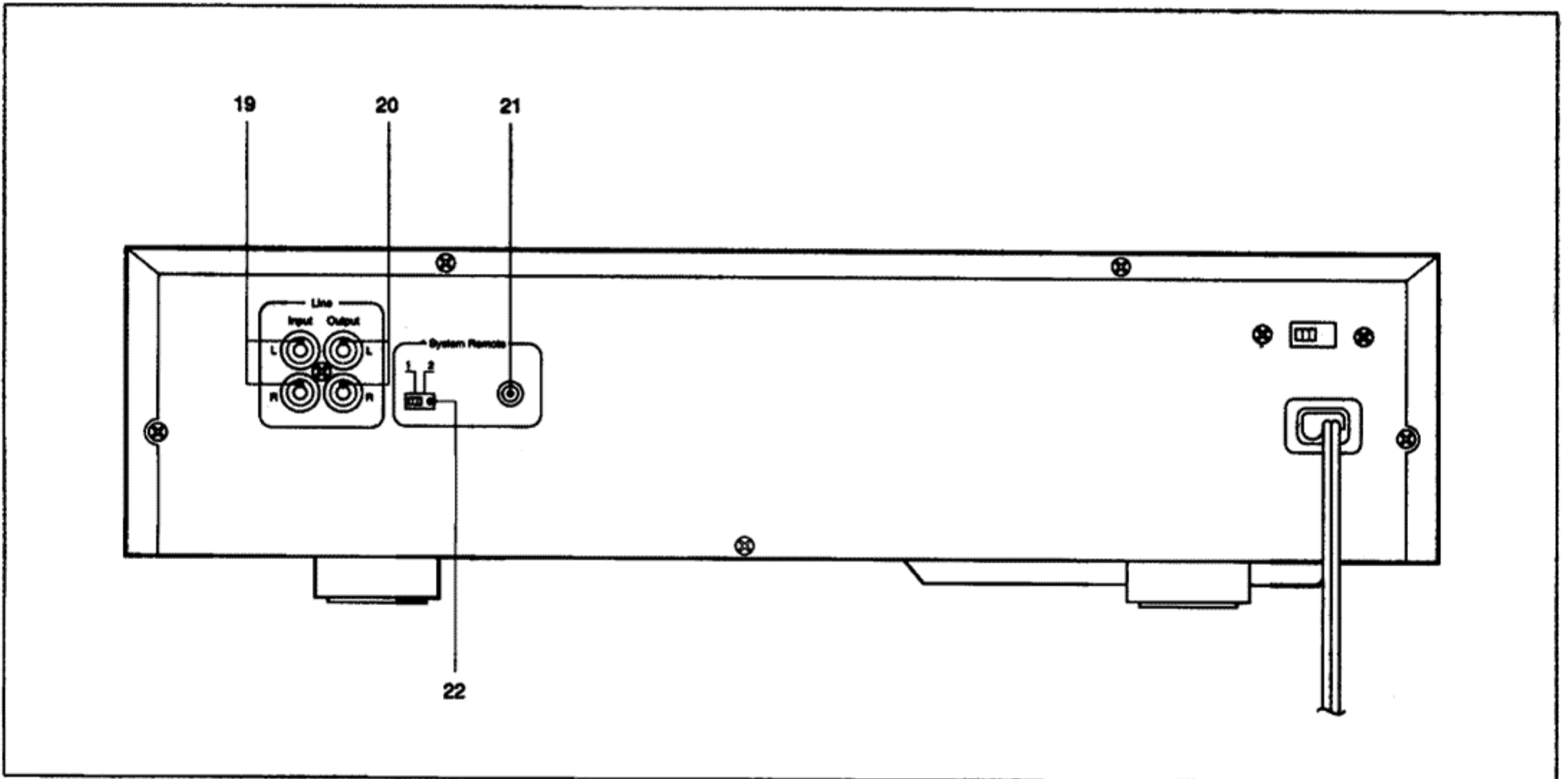
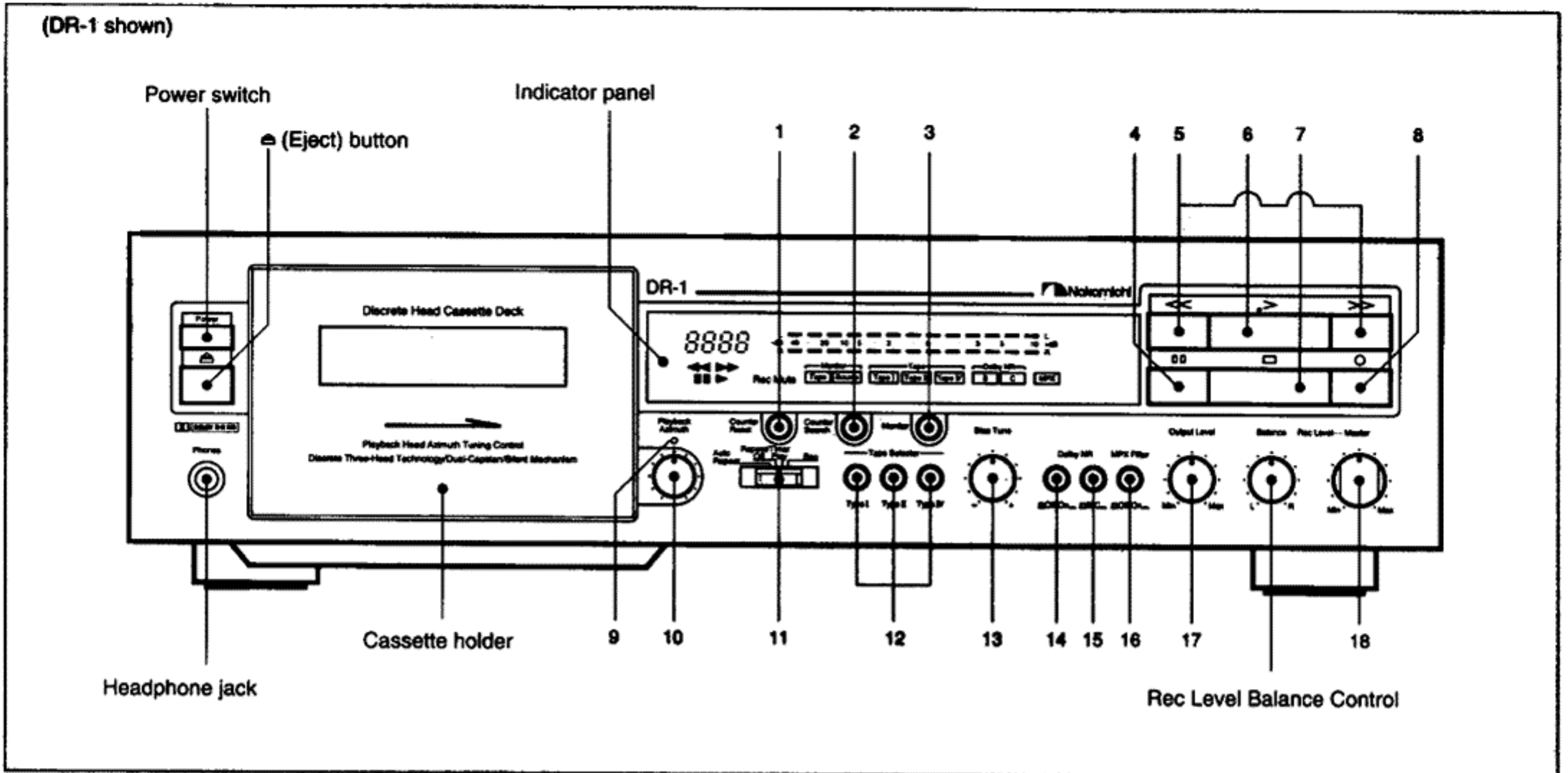

1. Counter Reset button

When the Counter Reset button is pressed, the tape counter will be reset to "0000".

2. Counter search button

In the playback, stop or pause mode, pressing the Counter Search button automatically locates the position of the tape corresponding to a tape counter indication of "0000". When the 0000 point is reached, the mode that was active before the search reentered.

3. Monitor button (DR-1/DR-2)

This unit incorporates an auto monitor function which automatically switches the output signal depending on the operation mode.

When the > button is pressed, the "Tape" position is automatically selected. When the deck is set to the Rec-Pause mode by pressing the ○ button, the output is automatically changed to source.

To compare the sound of the signal recorded on the tape with the source sound, or to check the sound quality or the recording level when performing manual adjustment, press the Monitor button to select the "TAPE".

4. ○○ (Pause) button

When the ○○ button is pressed during playback, the deck enters the pause mode.

To resume playback, press the > button.

5. << (Rewind)button/ >> (Fast Forward)button

The DR-1/DR-2 is equipped with a Program Check function which allows the checking of the tape's contents.



When the << (or >>) button is pressed twice, the deck enters the rewind (or fast-forward) mode for five seconds then enters the playback mode for five seconds; this process continues until Play (>) or Stop (□) is pressed.

6. > (Play)button

7. □ (Stop)button

8. ○ (Record) button

When the ○ button is pressed, the deck enters the Rec-Pause mode. To leave a silent portion during recording, hold the ○ button depressed. The silent

recording portion will be left as long as the  button is pressed. Releasing the  button resumes audio recording.

9. Playback Azimuth indicator (DR-1 only)

10. Playback Azimuth control (DR-1 only)

When the Playback Azimuth control is set to the center position during playback, the green indicator lights. If the control is set other than the center position, the indicator does not light. This only indicates that the mechanical center of the playback head of the cassette deck is out of nominal center position, and does not indicate that the azimuth with respect to the tape is incorrect. Since the optimum azimuth differs depending on the tape used, rotate the control while playing back to adjust the azimuth so that the high-frequency sound is as strong as possible.

During recording, the green indicator lights when the control is set to the center position. When it is set other than the center position, the red indicator blinks then lights steadily after several seconds. Before recording, be sure to set the control to the center position.

11. Repeat/Timer selector

When the Repeat/Timer selector is set to Auto Repeat, the tape is automatically rewound, and playback starts again when the tape reaches the beginning.

For timer playback, set the switch to the Play position and set the playback-start time with the (commercially available) audio timer.

For timer recording, set the switch to the Rec position and set the recording-start time with the (commercially available) audio timer.

When timer playback or recording is not required (for normal playback/recording), set the switch to the Off position.

12. Tape selector buttons

Select the tape type according to the tape used.

Press the Type I button for normal tapes, the Type II button for high bias (or chrome) tapes, and the Type IV button for metal tapes.

13. Bias Tune control

Bias requirements differ for various tape formulations. To obtain the best sound quality, it is advisable to always adjust bias before recording with this control. (See Record Level Adjustment)

14. Dolby NR On/Off switch

15. Dolby NR B/C switch

The Dolby B-Type NR is designed to reduce tape hiss and increase dynamic range in the upper frequency range. The effect of the Dolby C-Type NR takes effect at lower frequencies and dynamic range improvement is greater. Dolby C-Type NR will give best results for recording program material which has

- marked level differences (wide dynamic range)
- low signal level in the mid and upper frequencies
- a large amount of mid and upper frequency energy.

Set to the B position when playing back a tape recorded with Dolby B NR, and set to the C position when playing back a tape recorded with Dolby C NR. Dolby noise reduction will not be effective if it is set to the wrong position.

16. MPX Filter switch

Set this switch to ON when recording an FM stereo broadcast with Dolby NR activated. With the MPX Filter set to ON, the 19-kHz pilot in the FM stereo signal that could cause the Dolby NR to malfunction will be filtered out.

17. Output Level control (DR-1 only)

Turn this control to adjust the volume of the headphone output or when setting the output level so as to match the volume with that of other sources such as a CD player or tuner.

18. Rec Level Master control

Use this control to adjust the recording level of the L and R channels simultaneously. Adjust the balance between the L and R channels using the Rec Level Balance control.

19. Line Input terminals

Using the pin-jack cord provided, connect the Rec Out L (white) and R (red) jacks of the control amplifier, pre-main amplifier or receiver to these terminals.

20. Line Output terminals

Using the pin-jack cord provided, connect the Tape Playback L (white) and R (red) jacks of the control amplifier, pre-main amplifier or receiver to these terminals.

21. System Remote input terminal

When the System Remote input terminal is connected to the System Remote Output "Tape 1" or "Tape 2" terminal of a Nakamichi component having system remote control functions, this unit can be controlled remotely from that component.

22. System Remote 1/2 (Tape 1/2 Setup) switch

Set this switch to the Tape 1 position when the System Remote cable is connected to the System Remote Output "Tape 1" terminal of a Nakamichi component having control center functions, and set it to the Tape 2 position when connected to the System Remote Output "Tape 2" terminal. Be sure to turn the power of this unit OFF before changing the setting of the System Remote 1/2 switch.

Connection

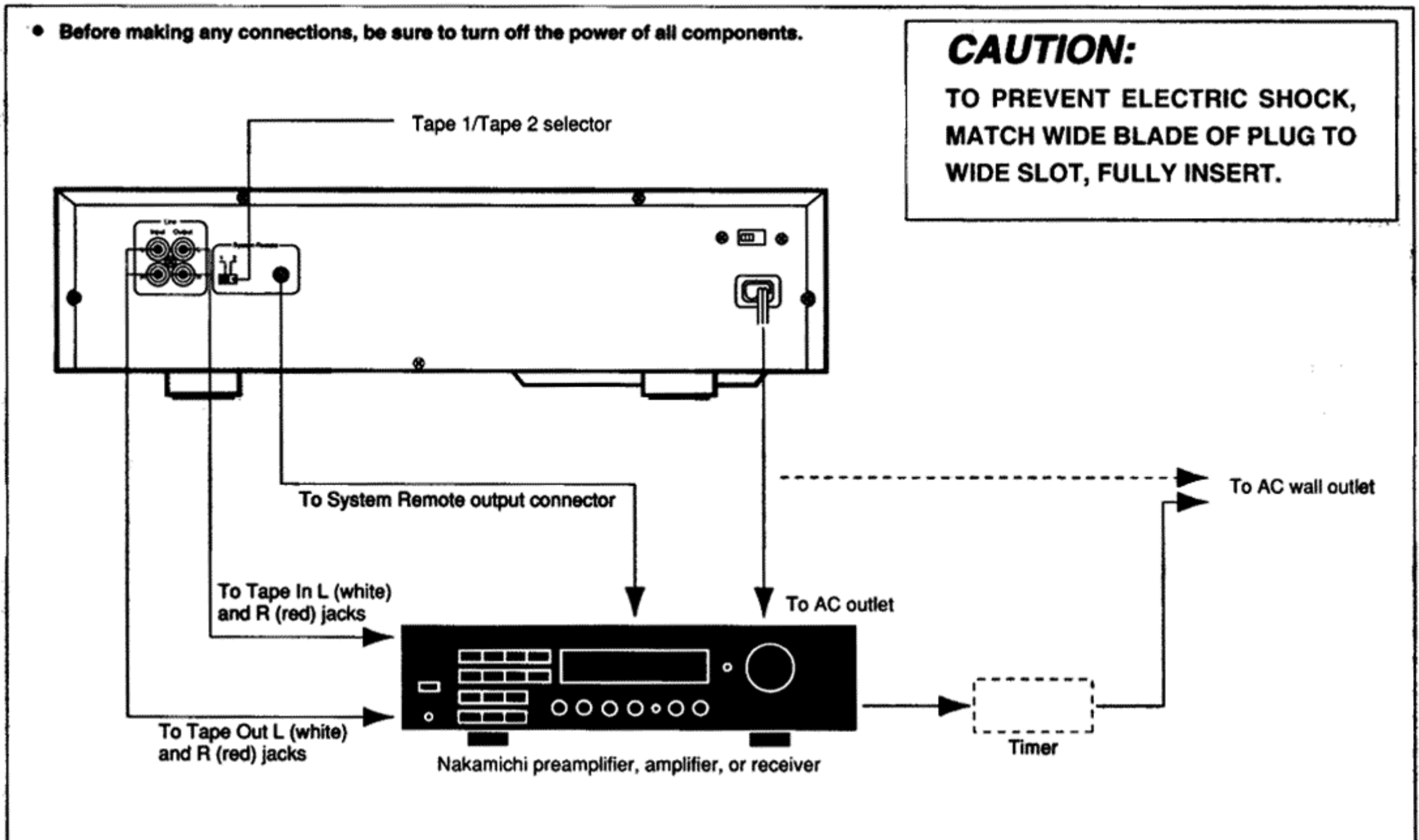

Playback

1. Press the Power switch.
2. Press the \triangle button.
3. Insert the cassette.
4. Close the cassette holder.
5. Select the tape type with the Tape Selector.
6. Set the Dolby NR On/Off switch.
7. Set the Dolby NR B/C switch.
8. Press the $>$ button.
9. Adjust the azimuth so that the high frequencies extend to the highest possible frequency. (DR-1 only)

Recording

1. Press the Power switch .
2. Press the \triangle button.
3. Insert the cassette.
4. Close the cassette holder.
5. Select the tape type with the Tape Selector.
6. Set the Dolby NR On/Off switch.
7. Set the Dolby NR B/C switch.
8. Set the Playback Azimuth control to the center position. (DR-1 only)

Record Level Adjustment

9. Set the Bias Tune control to the center position.
10. Press the \circ button.
11. Play back the source to be recorded.
12. Adjust the record level.
For normal and Type II tapes, adjust so that the +5 dB indicator lights briefly when the loudest sound is input.
For metal tapes, adjust so that the +8 dB indicator lights briefly when the loudest sound is input.
13. Adjust the record level balance.
14. Press the $>$ button.
15. Listen to the sound after it has been recorded on the tape, and compare it with the source sound.
(For DR-1/DR-2, alternate between Source and Tape sound by pressing the Monitor button during recording.)
16. Adjust the bias by rotating the Bias Tune control.
(Turn the Bias Tune control counterclockwise to increase the high frequency content of the tape. Turn the control clockwise to decrease the high frequency content of the tape. Adjust until the Tape sound is the same as the Source sound.)
17. Press the \circ button
18. Play back the source to be recorded.
19. Press the $>$ button.

Specifications

<DR-1>

• Track Configuration : 4tracks / 2-channel stereo • Heads : 3 (erase head × 1, record head × 1, playback head × 1) • Motors <Tape Transport> : DC servo motor (capstan drive) × 1, DC motor (reel drive) × 1 <Mechanism> : DC motor (cam drive) × 1 • Wow-and-Flutter : Less than ±0.06 % WTD Peak, Less than 0.035% WTD RMS • TapeSpeed : 1-7/8 ips. (4.8 cm/sec.) ±0.5% • Fast-Wind Time : Approx. 95 seconds (with C-60 cassette) • Frequency Response: 20-21,000 Hz ±3 dB (recording level -20 dB ,Type I/II/IV) • Signal - to - Noise Ratio <Dolby C Type NR On :> Better than 72 dB (400Hz, 3% THD, IHF A-WTD RMS) <70µs, Type V> Dolby B-type NR On : Better than 66dB (400Hz, 3% THD, IHF A-WTD RMS) <70µS, Type IV> • Total Harmonic Distortion : Less than 0.8% (400Hz, 0 dB, Type IV), Less than 1.0% (400Hz, 0dB, Type I/II) • Channel separation : Better than 37dB (1kHz, 0 dB) • Crosstalk : Better than 60dB (1kHz, 0dB) • Erasure : Better than 60dB (100Hz, ±10dB) • Bias Frequency : 105Hz • Input (Line) : 50mV/40 kΩ • Output (Line) 0.5V/2.2kΩ (400Hz, 0dB, output level control at max.) • Headphones : 5.0mW/8Ω (400Hz, 0dB, output level control at max.) • Power Source : 120, 230, 240V or 110-127/220-240 V AC, 50/60Hz • Power Consumption : 26W max. • Dimensions : 430(W) × 100(H) × 320(D)mm, 16-15/16(W) × 3-15/16(H) × 12-5/8(D) inches • Approximate Weight : 5.4kg/11 lbs. 14 oz.

<DR-2>

• Track Configuration : 4tracks / 2-channel stereo • Heads : 3 (erase head × 1, record head × 1, playback head × 1) • Motors <Tape Transport> : DC servo motor (capstan drive) × 1, DC motor (reel drive) × 1 <Mechanism> : DC motor (cam drive) × 1 • Wow-and-Flutter : Less than ±0.06 % WTD Peak, Less than 0.035% WTD RMS • TapeSpeed : 1-7/8 ips. (4.8 cm/sec.) ±0.5% • Fast-Wind Time : Approx. 95 seconds (with C-60 cassette) • Frequency Response: 20-21,000 Hz ±3 dB (recording level -20 dB ,Type I/II/IV) • Signal - to - Noise Ratio <Dolby C Type NR On :> Better than 72 dB (400Hz, 3% THD, IHF A-WTD RMS) <70µs, Type V> Dolby B-type NR On : Better than 66dB (400Hz, 3% THD, A-WTD RMS) <70µS, Type IV> • Total Harmonic Distortion : Less than 0.8% (400Hz, 0 dB, Type IV), Less than 1.0% (400Hz, 0dB, Type I/II) • Channel separation : Better than 37dB (1kHz, 0 dB) • Crosstalk : Better than 60dB (1kHz, 0dB) • Erasure : Better than 60dB (100Hz, ±10dB) • Bias Frequency : 105kHz • Input (Line) : 50mV/40 kΩ • Output (Line):0.5V/2.2kΩ (400Hz, 0dB) • Headphones : 5.0mW/8Ω (400Hz, 0dB) • Power Source : 120, 230, 240V or 110-127/220-240 V AC, 50/60Hz • Power Consumption : 26W max. • Dimensions : 430(W) × 100(H) × 320(D)mm, 16-15/16(W) × 3-15/16(H) × 12-5/8(D) inches • Approximate Weight : 5.4kg/11 lbs. 14oz.

<DR-3>

• Track Configuration : 4tracks / 2-channel stereo • Heads : 2 (erase head × 1, record/playback head × 1) • Motors <Tape Transport> : DC servo motor (capstan drive) × 1, DC motor (reel drive) × 1 <Mechanism> : DC motor (cam drive) × 1 • Wow-and-Flutter : Less than ±0.11 % WTD Peak, Less than 0.06% WTD RMS • TapeSpeed : 1-7/8 ips. (4.8 cm/sec.) ±0.5% • Fast-Wind Time : Approx. 80 seconds (with C-60 cassette) • Frequency Response: 20-20,000 Hz ±3 dB • Signal - to - Noise Ratio <Dolby C-Type NR On :> Better than 70 dB (400Hz, 3% THD, IHF A-WTD RMS) <70µs, Type V> Dolby B-type NR On : Better than 64dB (400Hz, 3% IHF THD, A-WTD RMS) <70µS, Type IV> • Total Harmonic Distortion : Less than 1.0% (400Hz, 0 dB, Type I / II / IV) • Channel separation : Better than 36dB (1kHz, 0 dB) • Crosstalk : Better than 60dB (1kHz, 0dB) • Erasure : Better than 60dB (100Hz, +10dB) • Bias Frequency : 105Hz • Input (Line) : 50mV/40 kΩ • Output (Line) : 0.5V/2.2kΩ (400Hz, 0dB, output level control at max.) • Headphones : 2,2mW/8Ω (400Hz, 0dB, output level control at max.) • Power Source : 120, 230, 240V or 110-127/220-240 V AC, 50/60Hz • Power Consumption : 20W max. • Dimensions : 430(W) × 100(H) × 320(D)mm, 16-15/16(W) × 3-15/16(H) × 12-5/8(D) inches • Approximate Weight : 5.4kg/11 lbs. 14oz.

* : Dimensions do not include protruding parts. Height is the panel height.

- Specifications and Design are subject to change for further improvement without notice.
- Dolby noise reduction manufactured under license from Dolby Laboratories Licensing Corporation.
- "Dolby" and the double D symbol  are trademarks of Dolby Laboratories Licensing Corporation.

Troubleshooting

Please check the following points before requesting service.

Condition → Remedy

Power is not turned ON.

- Check that the AC power plug is connected firmly to an AC outlet.

Tape does not run

- Close the cassette holder firmly.

Record button is pushed, but recording is not possible.

- Check whether record-prevention tab of the cassette side is removed.

Record mode is activated, but no sound is recorded.

- Increase record level.
- Check connection.

No playback sound.

- Check connection.
- Check the output volume level of the deck. <DR-1>

Tape sounds dull.

- Adjust playback azimuth (DR-1 only).
- Check Tape selector.
- Clean heads.
- Set the Dolby NR system to OFF when playing back a tape recorded without Dolby NR.

Hiss noise is heard.

- Demagnetize heads.
- Set Dolby NR to On for playback of tapes recorded with Dolby NR.

Old recordings cannot be fully erased.

- Clean erase head and pressure roller.

Sound is unstable or dropouts occur.

- Clean pressure roller and capstan.

Sound is distorted during recording/playback.

- Reduce record level.
- Check Tape Selector setting.

Hum is heard.

- Increase distance between cassette deck and appliances such as TV sets or air conditioners.
- Check connections.

Recording or playback starts when unit is turned on.

- Set the Repeat/Timer selector to Off.

Cleaning

Cleaning should be performed before each recording session and once every 10 hours of playback time. If the heads, capstan or pressure roller are dirty, dropouts may occur and high-frequency response and wow-and-flutter characteristics may be severely degraded. When cleaning, with the cassette holder open, remove the cassette holder door by lifting it up then pulling it towards you. After this, clean the heads, capstan and pinch rollers using cotton swabs dipped in cleaning fluid.

- We recommended a zero-residue fluorocarbon-based fluid which can be purchased at your local audio dealer.
- About once every 50 hours of use, the heads and capstan should be demagnetized with the Nakamichi DM-10 demagnetizer or any other properly designed wand-type demagnetizer. Otherwise, residual magnetism can induce noise and degrade high-frequency response.

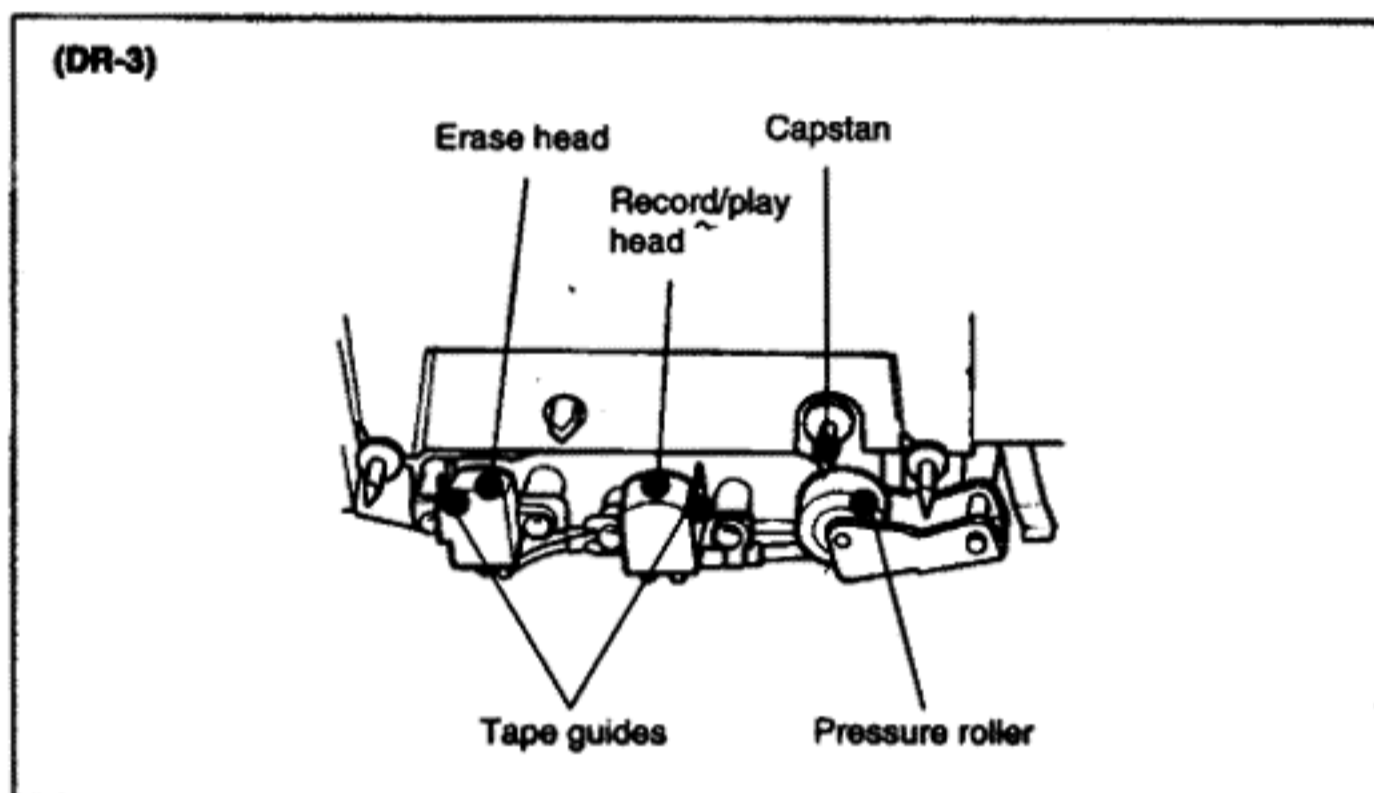
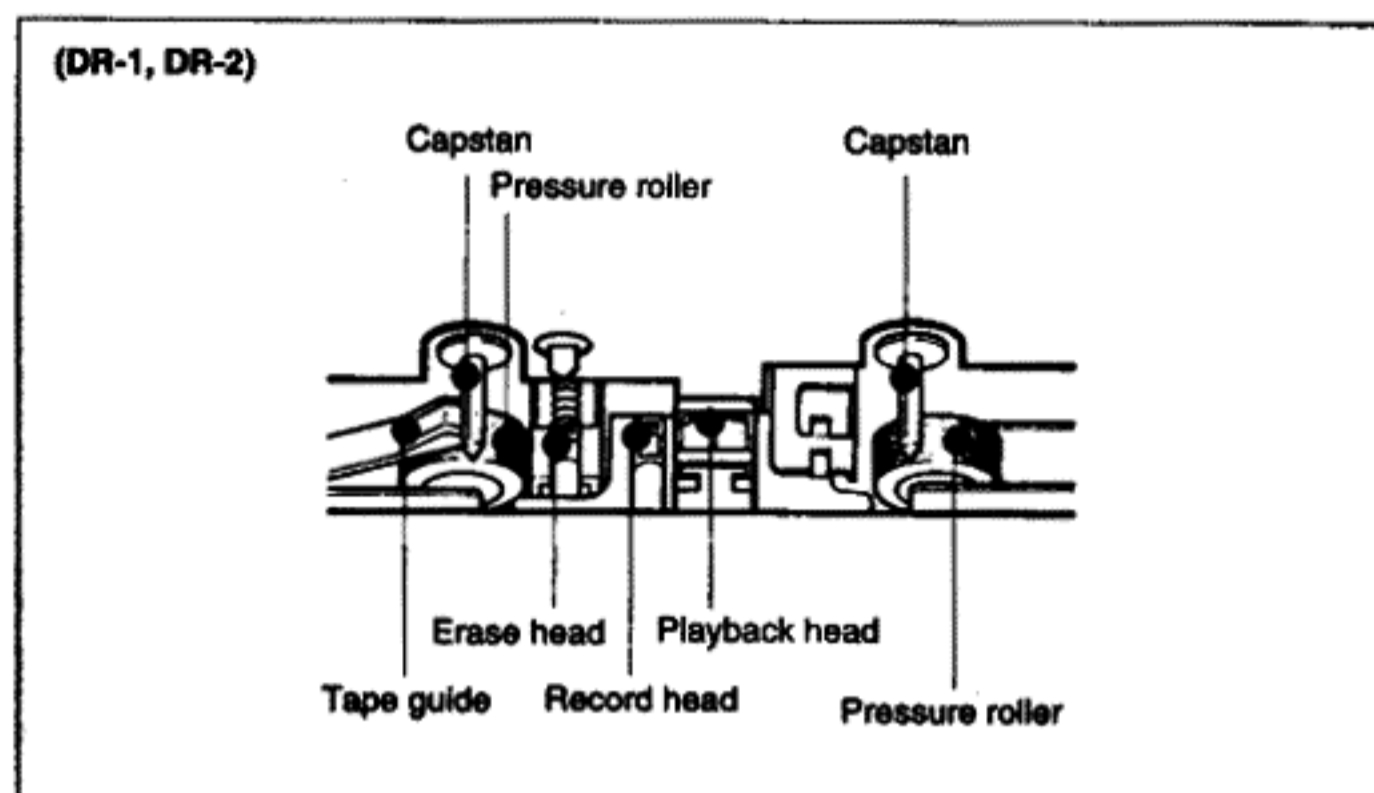

- Do not run the tape immediately after cleaning. Wait for about 5 minutes so that cleaning fluid completely evaporates before running the tape.

Nakamichi Corporation

1-153 Suzukicho, Kodaira, Tokyo 187

Phone: (0423) 42-1115

Nakamichi America Corporation

19701 South Vermont Ave., Torrance, CA 90502

Phone: (310) 538-8150

Nakamichi Canada

276 South West, Marine Drive, Vancouver, B. C. V5X2R4

Phone: (604) 324-7535

Nakamichi Australia

Unit 12, 620-632 Botany Road, Alexandria, N.S.W. 2015

Phone: (02) 667-0811

Nakamichi GmbH

Praunheimer Landstraße 32 6000 Frankfurt Main 90

Phone: (069) 7682021 (Office), 7682025 (Service)